

Article number: 0101140
 Description: Retaining ring A 185 DIN 471
 Spring steel
 Note: Fitted with ZGA pilers

Measures

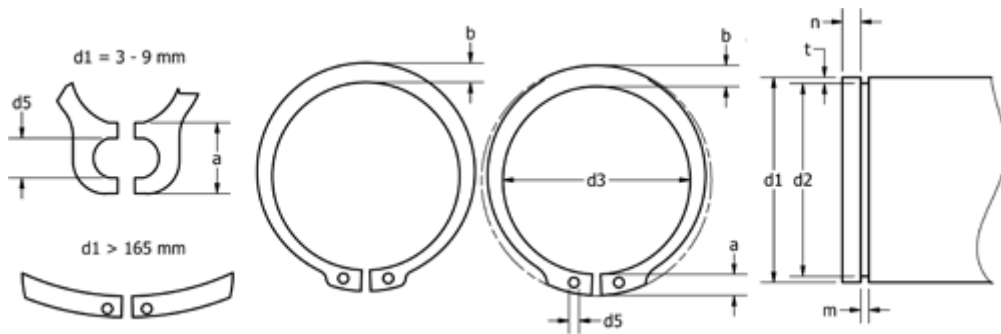

a max	= 14.2	FN kN	= 238.0	s	= 4.00
AN mm ²	= 1432.0	FRg kN	= 40.40	t	= 2.50
b	= 13.5	FR kN	= 336.00	tol	= -0.63
d1	= 185	g	= 5.0	tol	= -0.10
d2	= 180.0	K kN-mm	= 777.00	tol	= +0,63-1,50
d3	= 175.5	m min	= 4.15	Tong	= ZGA-5
d5 min	= 4.0	n abl x 1000	= 2.0	Weight kg/1000	= 200.000
Description	= A185	Nominal drive	= 7.5		